

Genie® GS™ -1930 & GS-1932

Specifications

Models	GS-1930		GS-1932	
Measurements	US	Metric	US	Metric
Working height max. - indoor ⁽¹⁾	25 ft 3 in	7.85 m	25 ft 3 in	7.85 m
Working height max. - outdoor ⁽¹⁾	20 ft 8 in	6.47 m	20 ft 8 in	6.47 m
A Platform height max. - indoor	19 ft 3 in	5.85 m	19 ft 3 in	5.85 m
A Platform height max. - outdoor	14 ft 8 in	4.47 m	14 ft 8 in	4.47 m
B Platform height - stowed	3 ft 5 in	1.04 m	3 ft 5 in	1.04 m
C Platform length - outside	5 ft 5 in	1.66 m	5 ft 5 in	1.66 m
C Platform length - outside, extended	8 ft 5 in	2.55 m	8 ft 5 in	2.55 m
Slide-out platform extension deck - length	3 ft	0.91 m	3 ft	0.91 m
D Platform width - outside	29.9 in	0.76 m	29.9 in	0.76 m
Guardrail height	3 ft 7 in	1.10 m	3 ft 7 in	1.10 m
Toeboard height	6 in	15 cm	6 in	15 cm
E Height - stowed (folding rails)	7 ft 1 in	2.16 m	7 ft 1 in	2.16 m
E Height - stowed (rails lowered)	5 ft 11 in	1.80 m	5 ft 11 in	1.80 m
F Length machine - stowed	6 ft	1.83 m	6 ft	1.83 m
F Length machine - stowed, extended	8 ft 11 in	2.72 m	8 ft 11 in	2.72 m
G Width	2 ft 6 in	0.76 m	2 ft 8 in	0.81 m
H Wheelbase	4 ft 4 in	1.32 m	4 ft 4 in	1.32 m
I Ground clearance (center) - pothole guards retracted	3.2 in	8 cm	3.2 in	8 cm
I Ground clearance - pothole guards deployed	0.9 in	2.30 cm	0.9 in	2.30 cm

Productivity

Maximum platform occupancy (in/out)	2/1	2/1	2/1	2/1
Lift capacity	500 lb	227 kg	500 lb	227 kg
Lift capacity - extension deck extended	250 lb	113 kg	250 lb	113 kg
Max. platform drive height	19 ft 3 in	5.85 m	19 ft 3 in	5.85 m
Drive speed - stowed	2.5 mph	4.0 km/h	2.5 mph	4.0 km/h
Drive speed - raised	0.5 mph	0.8 km/h	0.5 mph	0.8 km/h
Gradeability - stowed ⁽²⁾	25%	25%	25%	25%
Turning radius - inside/outside	0/5 ft 1 in	0/1.55 m	0/5 ft 1 in	0/1.55 m
Lifting speed - raise/lower	26/22 sec	26/22 sec	26/22 sec	26/22 sec
Tilt sensor activation (front to back/side to side)	3°/1.5°	3°/1.5°	3°/1.5°	3°/1.5°
Tires - solid non-marking	12x4.5 in	30.5x11.5 cm	12x4.5 in	30.5x11.5 cm

Power

Power	24 V DC (4 x 6 V 225 Ah)	24 V DC (4 x 6 V 225 Ah)	24 V DC (4 x 6 V 225 Ah)	24 V DC (4 x 6 V 225 Ah)
Hydraulic tank capacity (E-Drive)	1 gal	3.8 L	1 gal	3.8 L
Hydraulic tank capacity (hydraulic drive)	3.8 gal	14.2 L	3.8 gal	14.2 L

Weight⁽³⁾ and Floor Loading⁽⁴⁾

Weight	3,209 lb	1,456 kg	2,929 lb	1,329 kg
Tire load max.	1,460 lb	662 kg	1,435 lb	651 kg
Tire contact pressure	162 psi	1,118 kPa	159 psi	1,099 kPa
Occupied floor pressure	284 psf	13.6 kPa	244 psf	11.69 kPa

Sound and Vibration Levels

Sound Pressure level (ground workstation)	< 70 dBA	< 70 dBA	< 70 dBA	< 70 dBA
Sound Pressure level (platform workstation)	< 70 dBA	< 70 dBA	< 70 dBA	< 70 dBA
Vibrations	< 2.5 m/s ²	< 2.5 m/s ²	< 2.5 m/s ²	< 2.5 m/s ²

(1) The metric equivalent of working height adds 2 m to platform height. US adds 6 ft to platform height.

(2) Gradeability applies to driving on slopes and may vary depending on options and machine configurations. See operator's manual for details regarding slope ratings.

(3) Weight refers to standard configuration and may vary depending on options and/or country standards.

(4) Floor loading information is approximate and may vary depending on options and machine configurations. It should be used only with adequate safety factors.

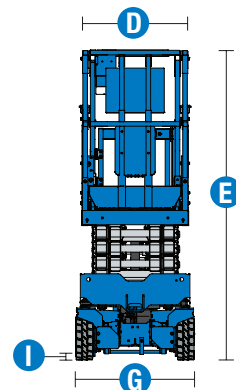
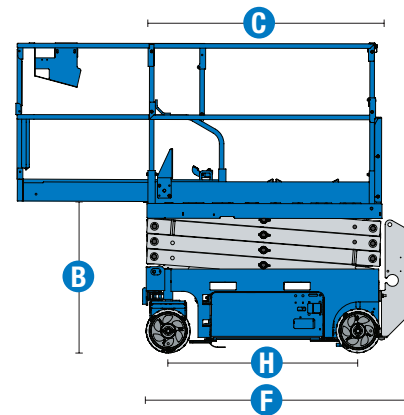
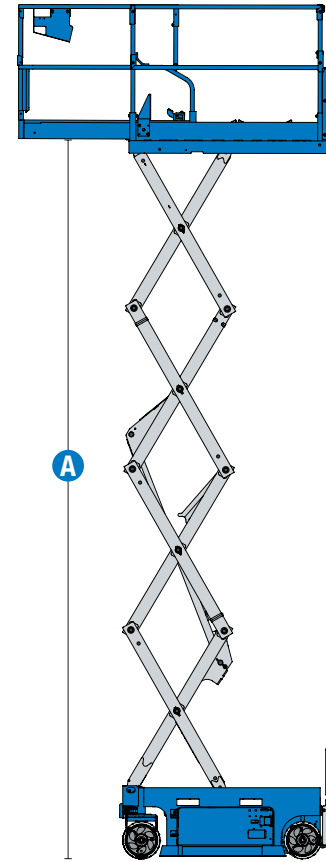

Genie® GS™ -1930 & GS-1932

Models

- GS-1930, E-Drive
- GS-1930, Hydraulic drive

Models

- GS-1932, E-Drive
- GS-1932, Hydraulic drive

Option availability		S	S+	BtO
Power	AGM Maintenance-free batteries			○
	Rear recessed charger receptacle	✓	✓	✓
Platform	Power to platform with RCBO		○	○
	Power to platform, no RCBO	✓	✓	✓
	Air line to platform			○
	Automotive-style horn		○	○
	Lift Tools Work Tray		○	○
	AC power to platform	✓	✓	✓
	Descent, tilt and motion alarm	✓	✓	✓
	Diamond plate platform	✓	✓	✓
	Dual LED flashing beacons	✓	✓	✓
	Electric horn	✓	✓	✓
	Folding rails, Half-height swing gate	✓	✓	✓
	Lanyard attachment points	✓	✓	✓
	Platform control guard	✓	✓	✓
	Platform load sense system	✓	✓	✓
	Proportional drive and lift	✓	✓	✓
	Slide out extension deck	✓	✓	✓
	SmartLink dual zone control system	✓	✓	✓
Chassis	Lift Connect Telematics		○	○
	Lift Connect with Access Manager upgrade		○	○
	Eco32 biodegradable hydraulic oil		○	○
	Auxiliary platform lowering	✓	✓	✓
	Dual wheel multi-disc brakes	✓	✓	✓
	Electric brake release	✓	✓	✓
	Fork pockets	✓	✓	✓
	Manual brake release	✓	✓	✓
	On board diagnostic system with battery indicator	✓	✓	✓
	Pothole protection	✓	✓	✓
	Solid non-marking tires	✓	✓	✓
Tech Pro Link connector	✓	✓	✓	
Tie-down and lifting points	✓	✓	✓	

- S Standard
- S+ Standard +
- BtO Build to Order
- Options



Indoor & Outdoor Use



Side Forklift Pockets



Optional E-Drive

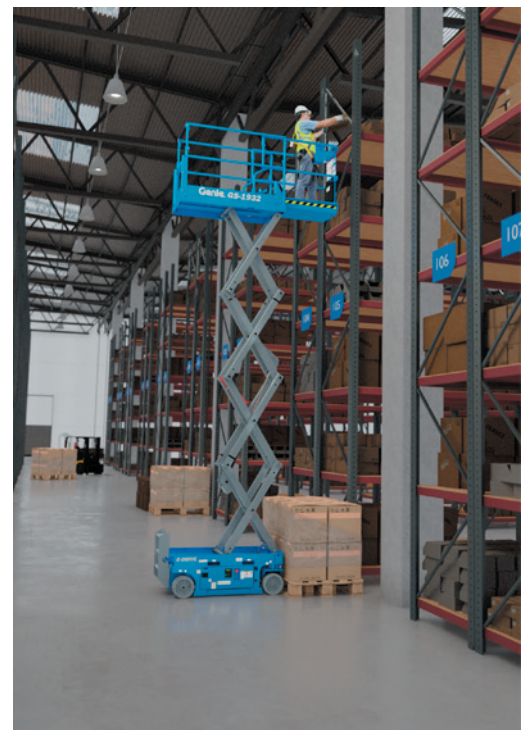

Genie Genuine Accessories⁽¹⁾

- Lift Tools Productivity Tools
- Lift Connect Telematics
- Tech Pro Link Handheld Device

(1) More accessories available from Genie Genuine Parts.

Product specifications are subject to change without notice or obligation. Photographs and/or drawings herein are for illustrative purposes only. Refer to the appropriate Operator's Manual for instructions on proper equipment use. Failure to follow instructions in the Operator's Manual may result in serious injury or death. The only warranty applicable to our equipment is the standard written warranty applicable to the particular product and sale and we make no other warranty, express or implied. Products and services listed may be trademarks, service marks or trade names of Terex Corporation and/or their subsidiaries in the USA and many other countries. Terex, Genie, Quality By Design, Xtra Capacity, Lift Power, Lift Guard, Lift Tools, Lift Connect and Tech Pro Link are registered trademarks of Terex Corporation or its subsidiaries.

Updated 06/21

GEN2560